



Thank you for your purchase of our new Stage Series Reverse Light Kit for the 2016+ Toyota Tacoma. This kit allows you to mount two LED pods under the rear bumper. Basic installation instructions are included below.



Please contact us if you have any questions.

This kit is designed to be activated with your factory reverse light and running light signals. The switch allows you to control the reverse light function. Leave the switch in the "1" position to activate any time your factory backup lights are turned on. The "2" position allows you to over-ride this, and turn the pods on at any time. Finally, "off" will keep the reverse lights off at all times.

If you don't plan on using the override function, you may want to leave the switch in the "1" position, and leave it in the engine bay.



1. Using a 12mm socket, remove the factory bolt on the underside of the truck bumper.

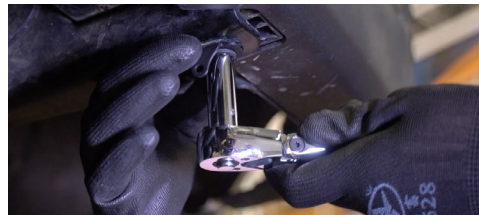

2. Secure the provided universal bracket with the factory bolt removed in the previous step. Then reinstall the factory bolt onto the truck bumper, making sure that the curved portion of the universal bracket is facing towards the rear of the vehicle.



3. Install your new SSC1 or SSC2 pod onto the universal bracket using the provided hardware. Using a 5/32" allen-key and a 3/8" wrench, tighten the screw such that the pod retains its position, but can pivot with force for aiming.

Repeat these steps on the other side of the vehicle.



4. Drop the tailgate to gain access to the three bolts located on the side of the taillight. Using a 10mm socket, remove the three bolts holding the taillight to the truck bed.

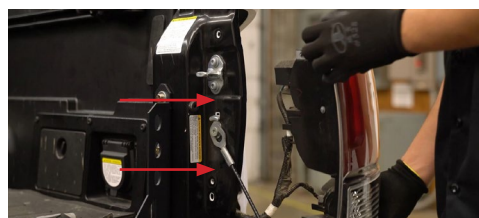

5. Remove the taillight housing by grabbing the top and bottom and applying force, pull outward.

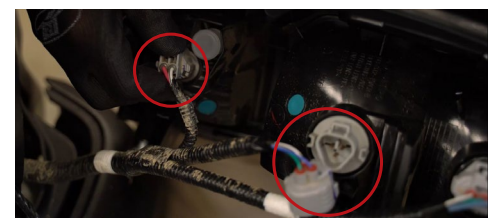

6. Disconnect the bottom two connectors from the back of the taillight.

See back for wiring instructions.

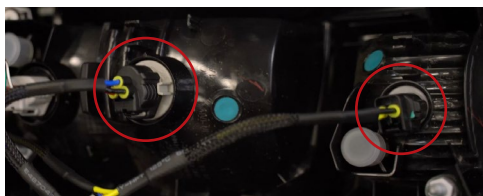
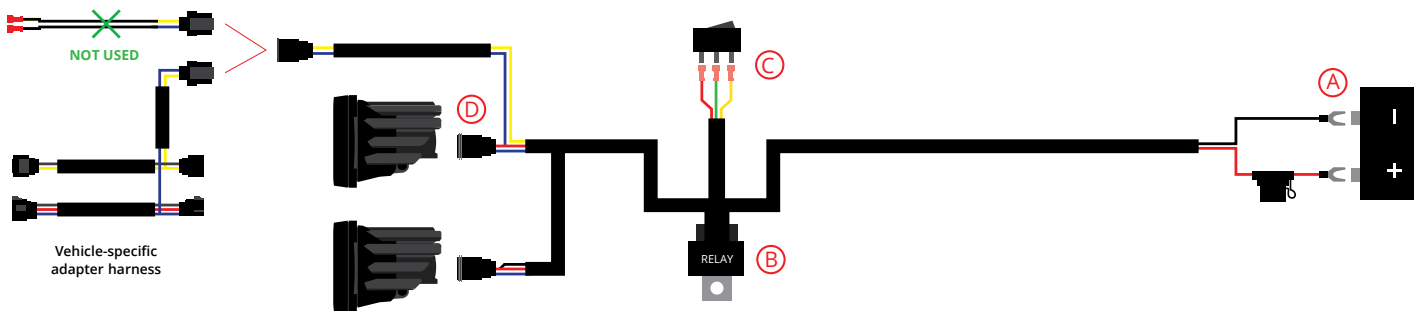

7. Connect the provided vehicle specific adapter harness in-line in between the connector on the OEM harness and the connector on the back of the taillight.

8. Feed the female 2-pin amp connector wire down through the taillight cavity hole, along side the factory harness.

9. Move the taillight back into position and reinstall the three factory bolts.

10. Connect the split ring terminals on the included wiring harness to the battery **A**. The black (ground) wire should be connected to the negative battery terminal or a factory grounding point and the red (power) wire should be connected to the positive battery terminal.

11. Determine a suitable location to mount the relay. **B** We recommend a location that is near the battery.

12. Determine where you would like to mount the switch. **C** If you plan on using the override function, you will want to mount the switch inside the cabin. This requires going through the vehicle's firewall. We recommend unplugging the toggle switch from the harness to route the wires more easily. Drill a 3/4" (19mm) hole for the switch. Then reconnect the wires to the switch and mount it.

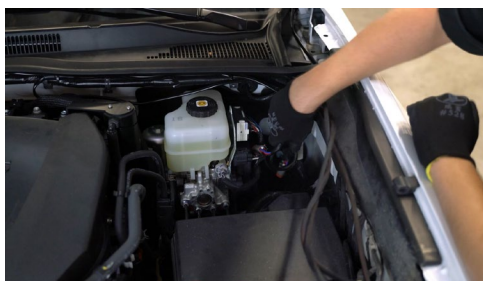

13. Route the connector end of the harness down underneath the vehicle however you see best fit. For this application, we recommend following the wheel well underneath, making sure to avoid any hot or moving parts.

14. Plug the DT connector into the back of the pods and the amp connector into the provided universal harness coming from the taillight **D**.

15. Aim the pods as desired. Then tighten down the hardware using a 5/32" allen-key and a 3/8" wrench. Aiming can be achieved with the pods installed on the vehicle. There is no need to remove the pods to re-aim.

NOTE: Disconnect the universal section from the amp connector on the provided universal wiring harness, this section will not be used.

Please contact **Diode Dynamics** should you have any questions about the installation or wiring process, at **314-205-3033** (10a-5p CST) or **contact@diodedynamics.com**.

NEED MORE HELP?

Scan the QR code to link to our installation video online!

We've taken the time to test our products on your vehicle. We can guarantee compatibility and fitment the first time – no guessing game! If you need more help with installation, watch our step-by-step video to walk you through the process.





This installation guide is for the following SKUs:

DD7158 Toyota Tacoma 2016+ Reverse Light Wiring Kit

DD7159 SSC1 Sport Toyota Tacoma 2016+ Reverse Light Kit
DD7160 SSC1 Pro Toyota Tacoma 2016+ Reverse Light Kit

DD7161 SSC2 Sport Toyota Tacoma 2016+ Reverse Light Kit
DD7162 SSC2 Pro Toyota Tacoma 2016+ Reverse Light Kit